



RESOURCES

Threaded Stem Casters

5/8" - 13 x 1" Threaded Stem Casters With Polyurethane Wheel

Certifications:



Features:

- Double Ball Bearing Raceway for Long Wear and Added Strength
- With or Without Top Lock Brake
- Raceway Dust Cover

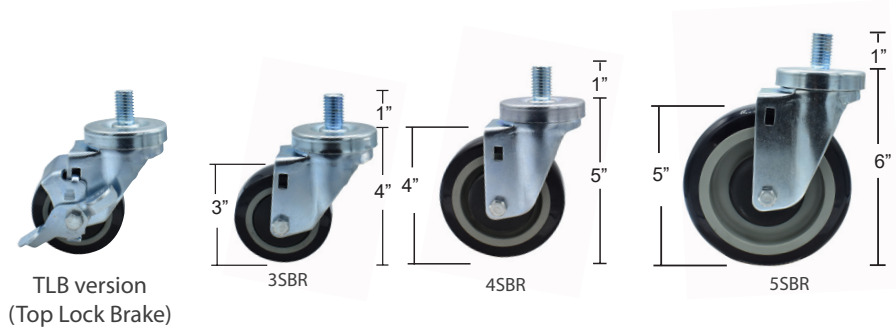

Material:

- Resistant to Acids & Caustics
- Temperature Range -45° to 180°F
- Non-Marking
- Zinc Plated
- Polyurethane Wheel

Part Number	Brake	Wheel Size	Capacity
3SBR-5ST-PLY	-	3"	300 LBS
3SBR-5ST-PLY-TLB	TLB	3"	300 LBS
4SBR-5ST-PLY	-	4"	300 LBS
4SBR-5ST-PLY-TLB	TLB	4"	300 LBS
5SBR-5ST-PLY	-	5"	300 LBS
5SBR-5ST-PLY-TLB	TLB	5"	300 LBS

PRODUCT DATA SHEET

RESOURCES

