



# SPEC SHEET

## KoolMore 18" x 54" Stainless Steel Floor Trough Drain, 14-Gauge with Subway-Style Grating & Removable Drain Basket, NSF Listed

---

Model: KM-FTG-1854

### FEATURES

---

- 14-gauge 304 stainless steel resists corrosion.
- 4-inch drain with 3-degree slope for fast drainage.
- Subway-style grate handles traffic and debris.
- Supports 871 lbs. and holds 12.68 gallons.
- Removable basket for easy maintenance.
- NSF certified with a 2-year warranty.



### CLOSE UP IMAGES

---



# TECHNICAL SPECS

## Dimensions

Length	56
Width	20
Height	7
Interior Depth	18
Interior Width	54
Interior Height	4
Weight Lbs	108

## Features & Materials

Top Capacity	871 lbs.
Water Capacity	12.68 gal.
Exterior Material	Stainless-Steel 304
Gauge Of Stainless Steel	9 & 14
Color Finish	Stainless-Steel
Grate Thickness	
Diameter Of Drain Line Connection	4 in.
Included	1 Drain Basket
Angle Of Downward Incline In Basin	3 degrees

## Certification

Certifications	NSF Listed
----------------	------------

# Plan View

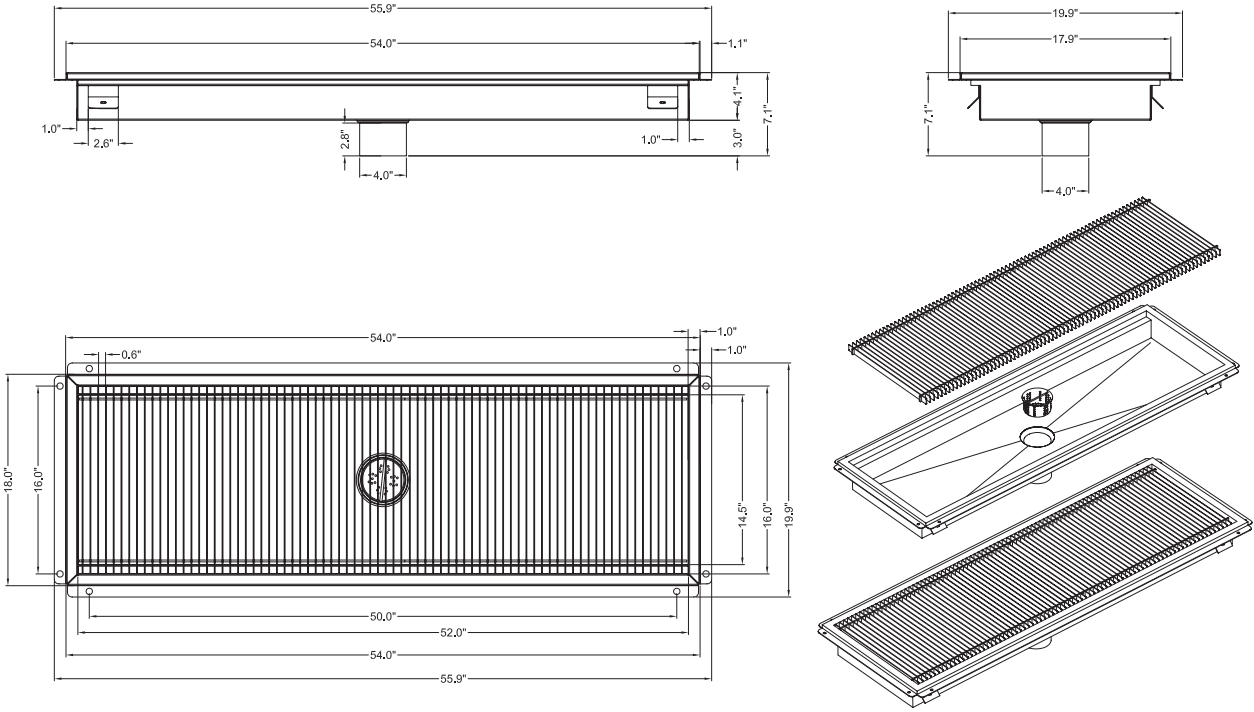

706 Eastern Parkway STE 1G, Brooklyn NY 11213  
718-576-6342  
info@koolmore.com