

PLAN VIEW
RIGHT HINGE
SELECT

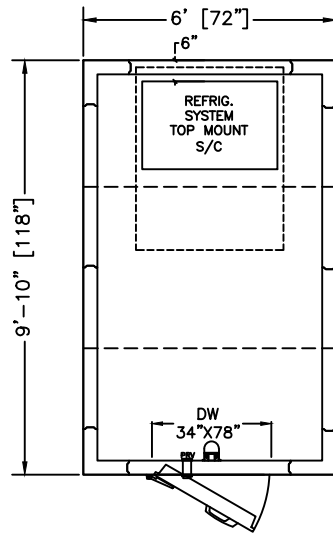

PLAN VIEW
LEFT HINGE
SELECT

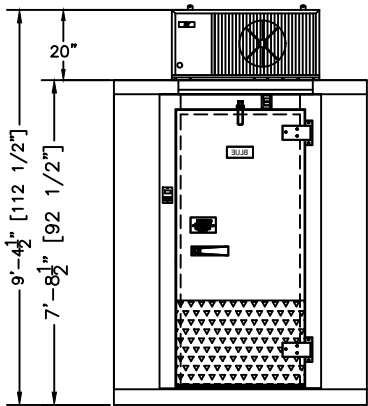

ELEVATION
RIGHT HINGE

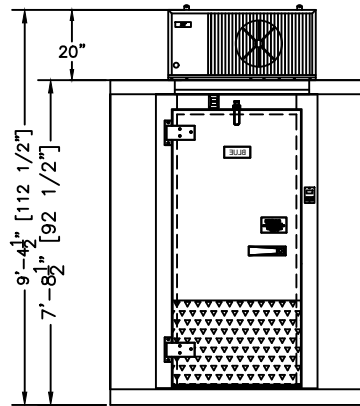

ELEVATION
LEFT HINGE

REFRIGERATION UNIT

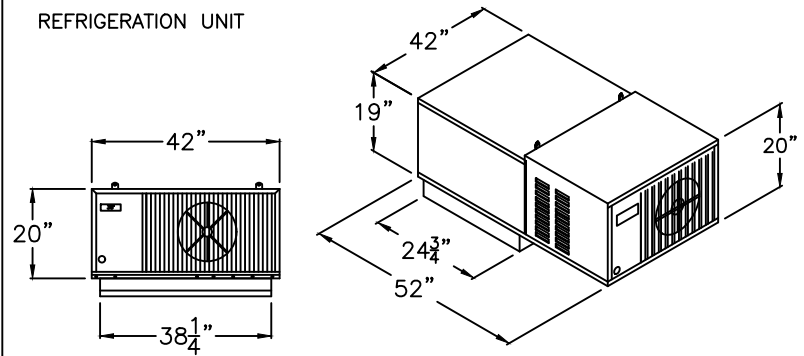

IMPORTANT: ALLOW 2 FEET CLEARANCE ABOVE UNIT
DO NOT STORE OBJECTS IN FRONT OR THE SIDES OF THE UNIT.
FOLLOW OEM'S CLEARANCE GUIDELINES TO ENSURE PROPER OPERATION

REFRIGERATION DESIGN SPECIFICATIONS

WALK-IN AMBIENT TEMP:	90°F
CONDENSER AMBIENT TEMP:	95°F
PULLDOWN:	24 Hours
HOLDING TEMP:	35°F
OPENINGS PER HOUR:	2

PRODUCT SPECIFICATIONS

MODEL:	BL610-F-SC
WALK-IN SPECIFICATIONS	
INTERIOR/EXTERIOR FINISH	26 GAUGE MILL EMBOSSED ACRYLUME OR 26 GAUGE STUCCO EMBOSSED GALVANIZED STEEL
ELECTRICAL (VOLTS/Hz/PH)	115/60/1
MAX AMP.	2.2

REFRIGERATION SYSTEM SPECIFICATIONS

ELECTRICAL (VOLTS/Hz/PH)	208-230/60/1
AMPS	16.5
WEIGHT (LBS)	275
MATCHING NEMA RECEPTACLE	

WALK-IN AND REFRIGERATION FREIGHT

TOTAL SHIPPING WEIGHT (LBS)	1677
MAXIMUM PALLET SIZE	48" X 120" X 102" HIGH
NUMBERS OF PALLETS	1

MODEL: BL610-F-SC

INDOOR-WITH FLOOR

FREEZER -10°F

SELF-CONTAINED SYSTEM

CUSTOMER APPROVAL

DATE: _____

SIGNATURE: _____

CONFIDENTIAL

THE DRAWINGS, TECHNICAL DATA, AND ALL OTHER INFORMATION SET FORTH IN THIS DOCUMENT COMPRISE TRADE SECRETS AND CONFIDENTIAL INFORMATION THAT IS THE EXCLUSIVE PROPERTY OF ARCTIC INDUSTRIES, LLC.

USE OF SUCH INFORMATION IS LIMITED TO THE PURPOSE FOR WHICH IT WAS PROVIDED AND NO RECIPIENT IS PERMITTED TO USE, COPY, OR DISCLOSE SUCH INFORMATION EXCEPT AS EXPRESSLY AUTHORIZED BY ARCTIC INDUSTRIES, LLC.