



BEVERAGE-AIR®

PROJECT: _____
 ITEM # _____ QTY: _____
 MODEL # _____
 AIA # _____ SIS # _____
 APPROVED: _____

BAR EQUIPMENT - BACK BAR REFRIGERATOR

Model: BBN48HC-GS-PT-S

SHALLOW DEPTH / SLIDING GLASS DOORS / PASS-THRU

**7 YEAR WARRANTY
 Parts, Labor, and Compressor**

CABINET CONSTRUCTION



- Stainless steel exterior
- Interior construction utilizes galvanized steel on walls and ceiling, heavy duty stainless steel floor
- Full electronic control
- 1" Stainless steel top standard
- ADA compliance (standard height)
- Self-closing sliding glass doors have black frame regardless of finish
- Door gaskets provide positive door sealing
- Stay-open feature and locks standard
- LED lighting
- Packaged products only
- Four (4) epoxy coated wire shelves
- Compressor standard on left side
- Balanced, forced air refrigeration system provides rapid chilling of product



OPTIONS & ACCESSORIES

- Right side compressor location (-ALT) (specify at time of unit order)
- Stainless steel back
- Wine model (40°-60° models)
- Wire shelf divider
- Additional shelves
- Additional shelf clips
- 3" or 6" Casters
- 6" Black legs
- Remote option* (see note on back on page)

REFRIGERATION SYSTEM

- Uses environmentally friendly, energy efficient R290 refrigerant, and meets all regulatory requirements for CARB, SNAP, DOE & more
- Adaptive defrost
- Epoxy coated evaporator coil
- Maintains product temperature between 36°F and 38°F



BEVERAGE-AIR®

Back Bar Refrigerator Model: BBN48HC-GS-PT-S

PLAN VIEW

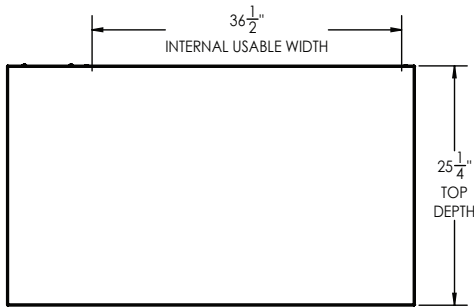

ELEVATION VIEW

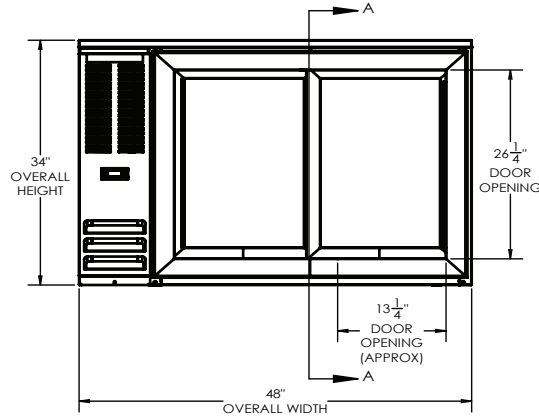

SIDE VIEW

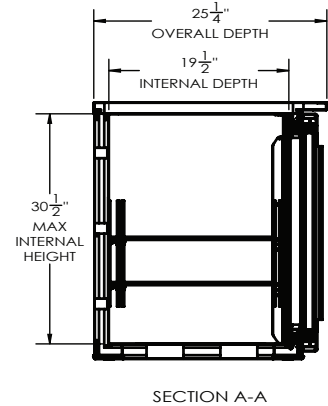

HEIGHT OPTIONS	
OPTIONS	HEIGHT
Standard Floor Mount	34"
3" Casters	37"
6" Casters	40"

EXTERNAL DIMENSIONAL DATA	
Width Overall (in)	48"
Depth Overall (in)	25 1/4"
Height Overall (in)	34"
Number of Doors	4
Door Openings (in)	13 1/4" x 26 3/16"
INTERNAL DIMENSIONAL DATA	
NET Capacity (cubic ft.)	12.56
Internal Width Useable (in)	36 1/2"
Internal Depth Overall (in)	19 1/2"
Internal Height Overall (in)	30 1/2"
Number of Shelves	4
Number of 1/2 Kegs	2

*NOTE: Remote units are field wired and come with 6" legs. Refrigerant must be specified at time of order.

We reserve the right to change specifications and product design without notice. Such revisions do not entitle the buyer to corresponding changes, improvements, additions or replacements for previously purchased equipment. Dimensional tolerances +/- 1/4". Metric dimensions (MM).

ELECTRICAL DATA	
Full Load Amps	3
Voltage	115/60/1
Nema Plug (8' cord)	5-15P
REFRIGERATION DATA	
Horsepower	1/4
Capacity (BTU/Hr)	1702
Heat Rejection (BTU/Hr)	2553
Charge (lbs/grams/ounces)	0.1212 / 55 / 1.94
SHIPPING DATA	
Gross Weight - Crated	345 lbs.
Height - Crated (in)	42 3/16"
Width - Crated (in)	50 3/4"
Depth - Crated (in)	36 1/2"

ELECTRICAL CONNECTION



115/60/1
NEMA 5-15P

Unit pre-wired at factory and include 8' long cord and plug set.

3779 Champion Blvd., Winston-Salem, NC 27105 | 888-845-9800 | Fax: 336-245-6453 | Beverage-Air.com | Sales@bevair.com

Date Issued 8/25 | Printed in U.S.A.